

VALVES SERIES 70, PNEUMATIC

TECHNICAL DATA		1/8" NPT	1/4" NPT	3/8" NPT	1/2" NPT
Operating pressure	psi	Vacuum to 145			
Minimum pilot pressure					
• monostable	psi	36.3			
• bistable	psi	14.5			
Operating temperature range	°F	14 to + 140			
Nominal diameter	in	0.20	0.30	0.52	0.59
Conductance C	scfm/psi	0.30	0.65	1.23	2.37
Critical ratio b	psi/psi	0.32	0.27	0.32	0.43
Flow rate at 87 psi ΔP 7.25 psi	scfm	14	26.5	55.2	113
Flow rate at 87 psi ΔP 14.5 psi	scfm	19.5	39	75	163
		Cv 0.55	Cv 1.1	Cv 2.1	Cv 4.6
TRA / TRR monostable at 87 psi	ms	6/15	7/15	5/28	16/46
TRA / TRR bistable at 87 psi	ms	7/7	7/7	13/13	16/16
Hand operation		-	-	-	*



KEY TO CODES

P N V		2		3		P N		S		N C		U	
FAMILY		DIMENSIONS		FUNCTION		OPERATORS 14		RESETTING (12)		FURTHER DETAILS		THREAD	
PNV	pneumatic valves	2	1/8"	3	3/2	PN	pneumatic	S	mechanical springs	OO	5/2	U	NPT
		3	1/4"	5	5/2			B	bistable	NC	normally closed		
		C	3/8"	6	5/3			D	differential	NO	normally open		
		4	1/2"					O	stable for 5/3	CC	closed centres		
								A	pneumatic/mechanical spring*	OC	open centres		
										PC	pressure centres		
									*on demand				

VALVES SERIES 70, PNEUMATIC, 1/8" NPT

MONOSTABLE 3/2 NO, 1/8" NPT

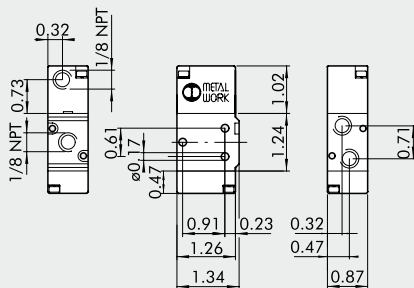

MONOSTABLE 3/2 NC, 1/8" NPT

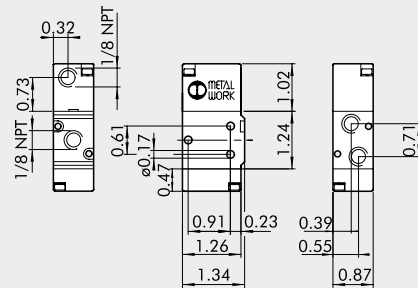

Symbol	Code	Abbrev.	Weight [lb]
	7010010400U	PNV 23 PNS NO U	0.181

Symbol	Code	Abbrev.	Weight [lb]
	7010010200U	PNV 23 PNS NC U	0.181

MONOSTABLE 5/2, 1/8" NPT

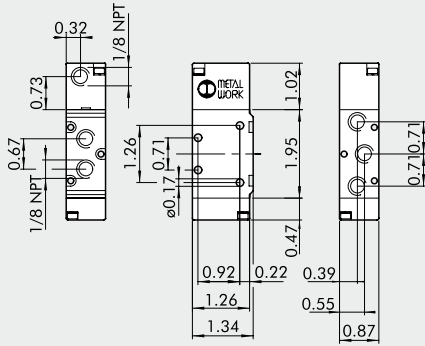

Symbol	Code	Abbrev.	Weight [lb]
	7010011100U	PNV 25 PNS OO U	0.238

BISTABLE 5/2, 1/8" NPT

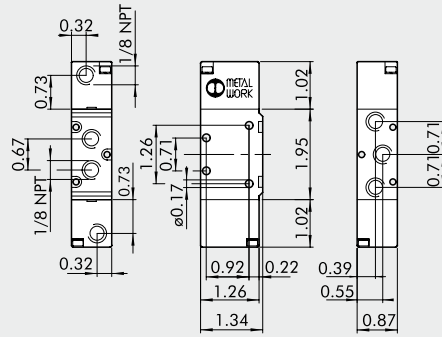

Symbol	Code	Abbrev.	Weight [lb]
	7010011200U	PNV 25 PNB OO U	0.269

	7010011300U	PNV 25 PND OO U	0.282
--	-------------	-----------------	-------

BISTABLE 3/2, 1/8" NPT

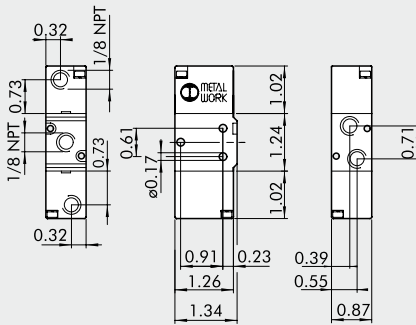

Symbol	Code	Abbrev.	Weight [lb]
	7010010100U	PNV 23 PNB OO U	0.212

MONOSTABLE 5/3, 1/8" NPT

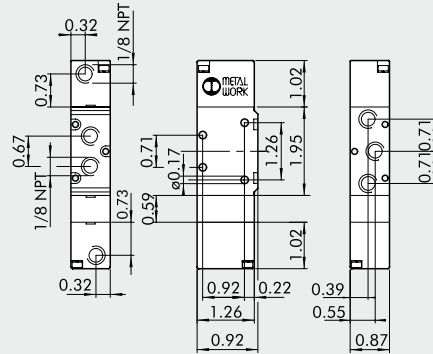

Symbol	Code	Abbrev.	Weight [lb]
	7010012100U	PNV 26 PNS CC U	0.331

	7010012200U	PNV 26 PNS OC U	0.331
--	-------------	-----------------	-------

	7010012300U	PNV 26 PNS PC U	0.331
--	-------------	-----------------	-------

NOTES

VALVES SERIES 70, PNEUMATIC, 1/4" NPT

MONOSTABLE 3/2 NO, 1/4" NPT

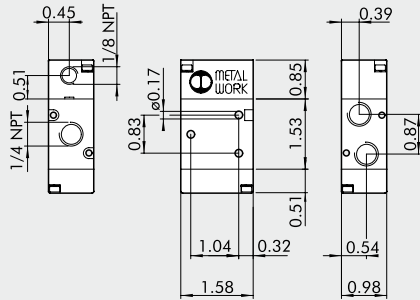

Symbol	Code	Abbrev.	Weight [lb]
	7020010400U	PNV 33 PNS NO U	0.273

MONOSTABLE 3/2 NC, 1/4" NPT

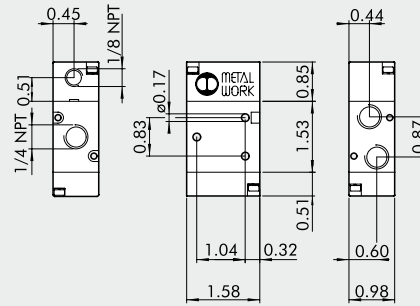

Symbol	Code	Abbrev.	Weight [lb]
	7020010200U	PNV 33 PNS NC U	0.269

MONOSTABLE 5/2, 1/4" NPT

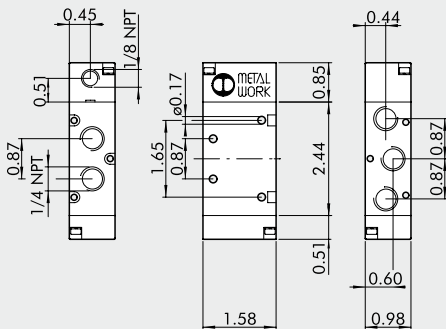

Symbol	Code	Abbrev.	Weight [lb]
	7020011100U	PNV 35 PNS OO U	0.384

BISTABLE 5/2, 1/4" NPT

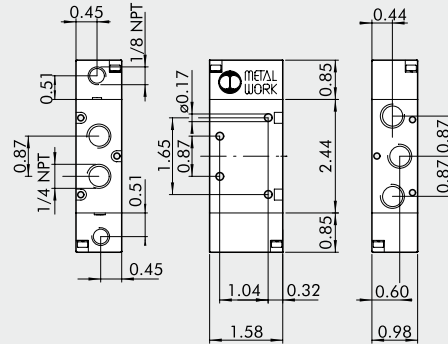

Symbol	Code	Abbrev.	Weight [lb]
	7020011200U	PNV 35 PNB OO U	0.384
	7020011300U	PNV 35 PND OO U	0.437

BISTABLE 3/2, 1/4" NPT

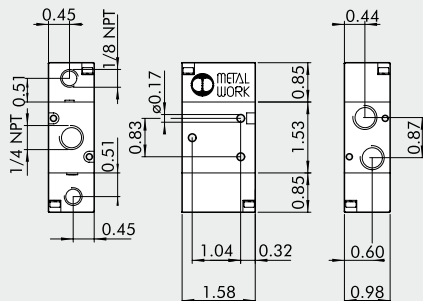

Symbol	Code	Abbrev.	Weight [lb]
	7020010100U	PNV 33 PNB OO U	0.269

MONOSTABLE 5/3, 1/4" NPT

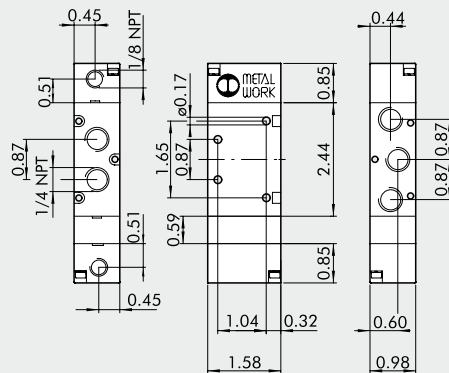

Symbol	Code	Abbrev.	Weight [lb]
	7020012100U	PNV 36 PNS CC U	0.273
	7020012200U	PNV 36 PNS OC U	0.273
	7020012300U	PNV 36 PNS PC U	0.273

VALVES SERIES 70, PNEUMATIC, 3/8" NPT

MONOSTABLE 3/2 NO, 3/8" NPT

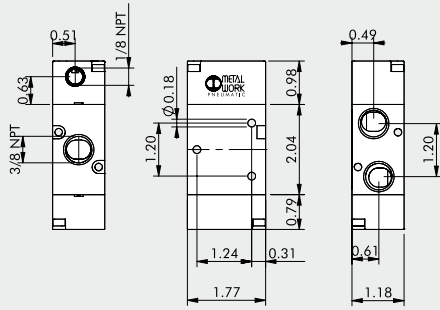

Symbol	Code	Abbrev.	Weight [lb]
	7040010400U	PNV C3 PNS NO U	0.491

MONOSTABLE 3/2 NC, 3/8" NPT

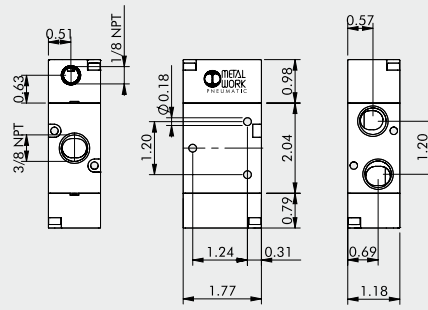

Symbol	Code	Abbrev.	Weight [lb]
	7040010200U	PNV C3 PNS NC U	0.491

MONOSTABLE 5/2, 3/8" NPT

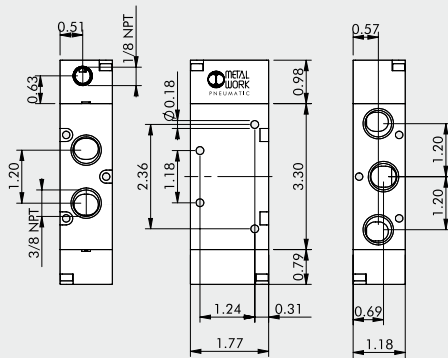

Symbol	Code	Abbrev.	Weight [lb]
	7040011100U	PNV C5 PNS OO U	0.725

BISTABLE 5/2, 3/8" NPT

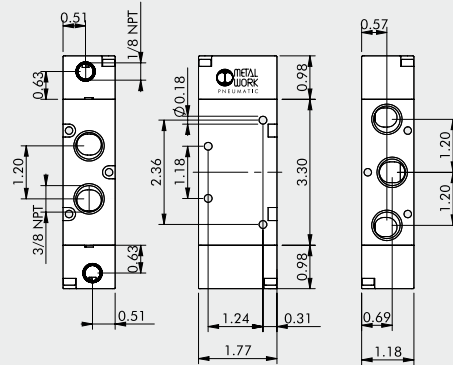

Symbol	Code	Abbrev.	Weight [lb]
	7040011200U	PNV C5 PNB OO U	0.714
	7040011300U	PNV C5 PND OO U	0.793

BISTABLE 3/2, 3/8" NPT

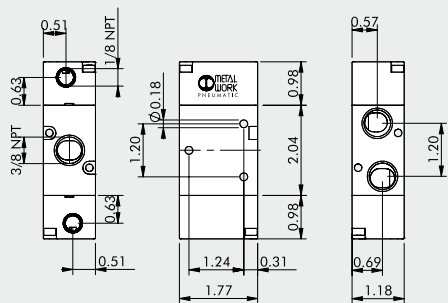

Symbol	Code	Abbrev.	Weight [lb]
	7040010100U	PNV C3 PNB OO U	0.507

MONOSTABLE 5/3, 3/8" NPT

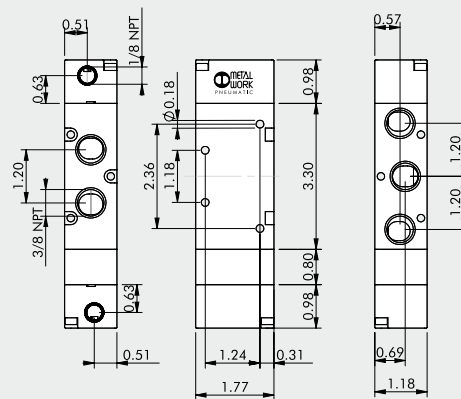

Symbol	Code	Abbrev.	Weight [lb]
	7040012100U	PNV C6 PNS CC U	0.906
	7040012200U	PNV C6 PNS OC U	0.901
	7040012300U	PNV C6 PNS PC U	0.901

VALVES SERIES 70, PNEUMATIC, 1/2" NPT

MONOSTABLE 3/2 NO, 1/2" NPT

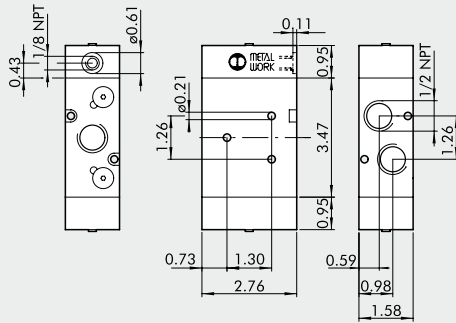

Symbol	Code	Abbrev.	Weight [lb]
	7030010400U	PNV 43 PNS NO U	2.00

MONOSTABLE 3/2 NC, 1/2" NPT

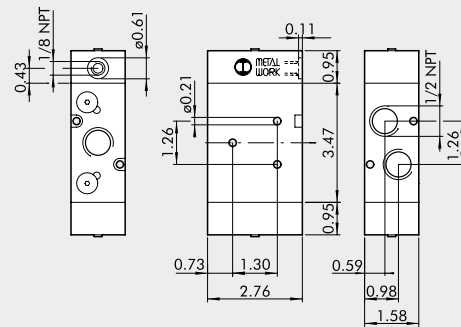

Symbol	Code	Abbrev.	Weight [lb]
	7030010200U	PNV 43 PNS NC U	2.00

MONOSTABLE 5/2, 1/2" NPT

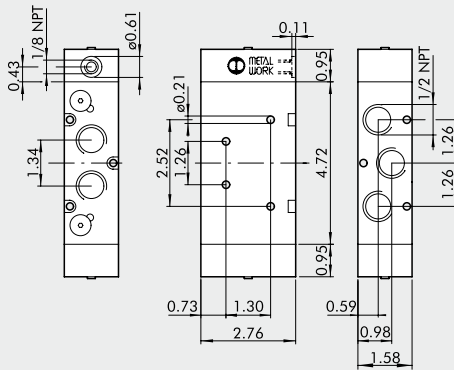

Symbol	Code	Abbrev.	Weight [lb]
	7030011100U	PNV 45 PNS OO U	2.404

BISTABLE 5/2, 1/2" NPT

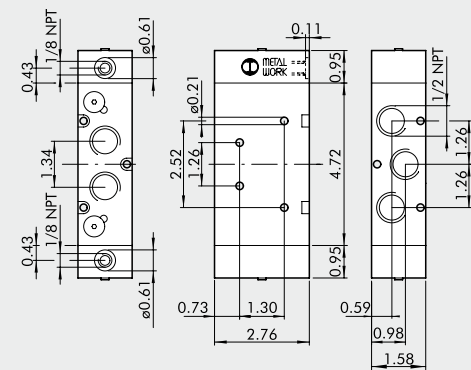

Symbol	Code	Abbrev.	Weight [lb]
	7030011200U	PNV 45 PNB OO U	2.375
	7030011300U	PNV 45 PND OO U	2.404

BISTABLE 3/2, 1/2" NPT

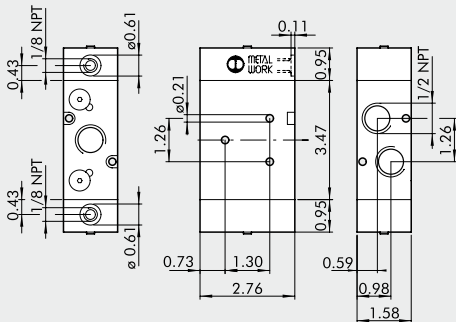

Symbol	Code	Abbrev.	Weight [lb]
	7030010100U	PNV 43 PNB OO U	2.031

MONOSTABLE 5/3, 1/2" NPT

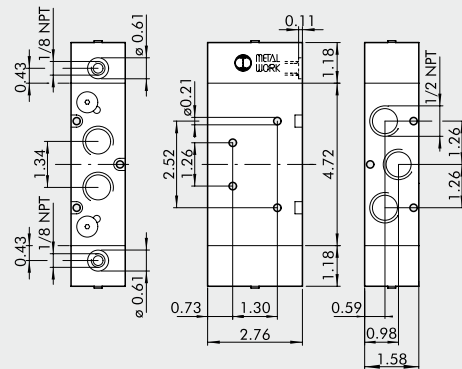

Symbol	Code	Abbrev.	Weight [lb]
	7030012100U	PNV 46 PNS CC U	2.646
	7030012200U	PNV 46 PNS OC U	2.633
	7030012300U	PNV 46 PNS PC U	2.637