

ROTARY ACTUATOR SERIES R1

Rack-type rotary actuators in various configurations:

- Configuration with standard magnet
- Version with male pinion or female hole
- Mechanical stroke adjustment
- Special configurations on request

The central body has ISO bore holes for wall fixing using ISO pin and/or flange fittings.

N.B.: We always suggest to use flow microregulators. During the setup of the actuator, start with CLOSE flow microregulators, and open gradually till the achievement of the required speed.

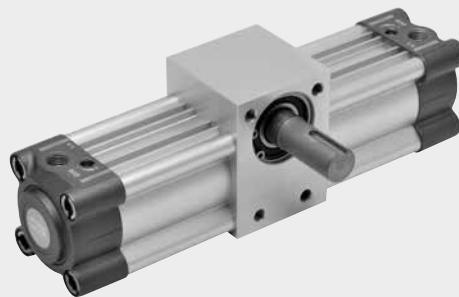

TECHNICAL DATA	Ø 32	Ø 40	Ø 50	Ø 63	Ø 80	Ø 100	Ø 125	
Operating pressure	10 bar (1 MPa - 145 psi)							
Temperature range	°C -10 to 80							
Fluid	Filtered lubricated or unlubricated air. Lubrication, if used, must be continuous							
Rotation angle	90°; 180°; 270°; 360°							
Configuration	Magnetic standard cushioned							
Actual rotation angle	See next page							
Admissible kinetic energy	Joule	1.8	3	5	12	28	40	66

DIMENSIONS - FORCES AND MOMENTS

Ø	Cr Theoretical torque at 6 bar [Nm]	Fa Max axial load [N]	Fr Max radial Load [N]	M Max tilting moment [Nm]
32	4.5	2500	570	18
40	12.5	2800	650	25
50	16	4500	1000	45
63	32	5600	1310	68
80	70	8500	2040	135
100	120	12200	2920	230
125	300	20000	4640	480

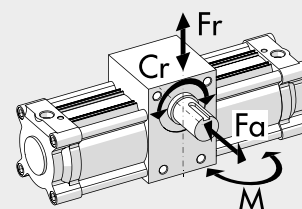

WEIGHTS [kg]

Ø	VERSION W165__1__				VERSION W165__2__				VERSION W166__1__				VERSION W166__2__			
	Rotation angle				Rotation angle				Rotation angle				Rotation angle			
	90°	180°	270°	360°	90°	180°	270°	360°	90°	180°	270°	360°	90°	180°	270°	360°
32	1.15	1.25	1.36	1.47	1.25	1.36	1.47	1.58	1.00	1.20	1.30	1.40	1.20	1.30	1.40	1.50
40	1.65	1.80	1.90	2.00	1.80	1.95	2.05	2.15	1.55	1.65	1.75	1.85	1.60	1.75	1.90	2.05
50	2.50	2.70	2.90	3.05	2.27	2.90	3.07	3.25	2.35	2.50	2.70	2.85	2.50	2.75	2.90	3.07
63	3.60	3.80	4.05	4.25	3.85	4.05	4.30	4.50	3.35	3.55	3.80	4.00	3.50	3.80	4.00	4.20
80	7.40	7.90	8.30	8.80	7.80	8.30	8.80	9.30	6.80	7.30	7.80	8.30	7.20	7.70	8.20	8.70
100	11.60	12.40	13.20	13.90	12.20	12.90	13.60	14.40	10.50	11.20	12.00	12.70	11.00	11.70	12.50	13.30
125	20.00	21.70	23.30	25.00	20.60	22.30	23.90	25.60	18.80	20.50	22.10	23.80	19.40	21.10	22.70	24.40

COMPONENTS

- ① BARREL: profiled anodized aluminium alloy
- ② HEAD: die cast aluminium
- ③ CUSHIONING NEEDLE: OT 58 with needle out movement safety system even when fully open
- ④ BUFFER + Static O-rings: NBR or FKM/FPM
- ⑤ PISTON: aluminium
- ⑥ PISTON GASKET: NBR
- ⑦ MAGNET: plastoferrite
- ⑧ RACK: nitrided steel
- ⑨ PIGNON MALE/FEMALE: nitrided alloy steel
- ⑩ BALL BEARING
- ⑪ CENTRAL BODY: anodized aluminium
- ⑫ RACK GUIDE BUSH: self-lubricating sintered bronze
- ⑬ REGULATION SCREW: anodized aluminium

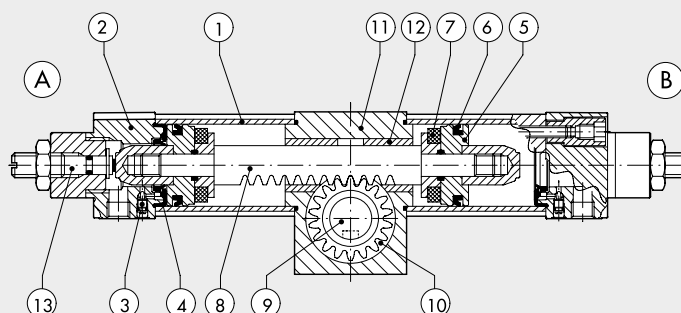

DIMENSIONS OF ROTARY ACTUATOR R1 Ø 32 to 125

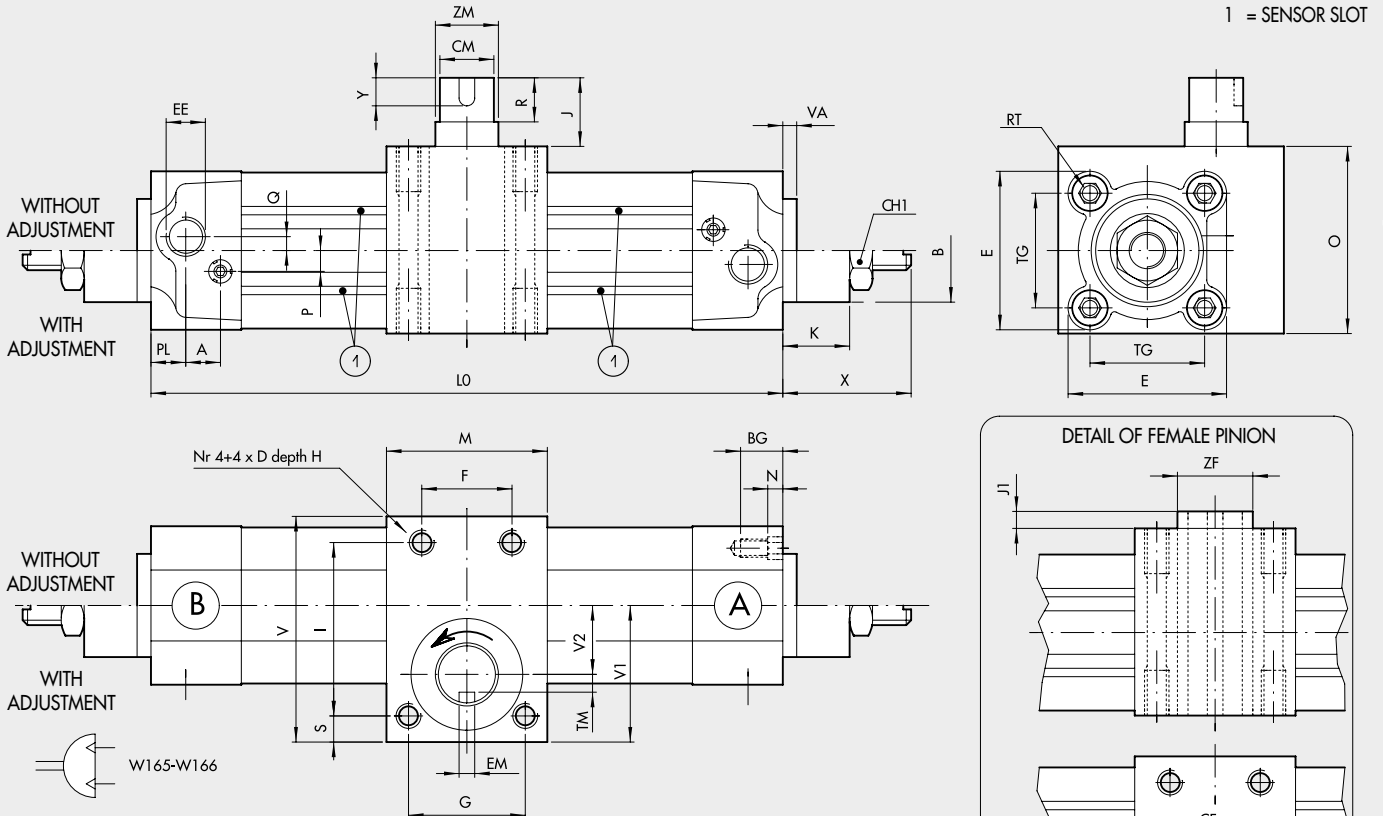

ACTUATORS
ROTARY ACTUATOR SERIES R1

Note: with the key slot in the position specified, the piston is in contact with head **A**

ACTUAL ROTATION ANGLE

VERSION WITH ADJUSTMENT

VERSION WITHOUT ADJUSTMENT

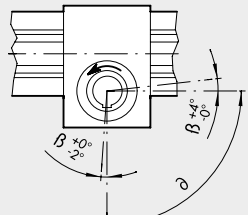
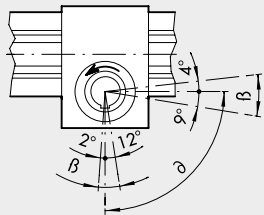

β = Adjustment
 δ = Nominal rotation angle

β = Manufacturing tolerance
 δ = Nominal rotation angle

Ø	L0 ±1 for ROTATION ANGLE				Δ	A	B	BG	CM ⁹⁷	CF ⁹⁷	CHI	D	E	EE	EF ^{D10}	EM ^{H9}	F	G	H	I	J
	90°	180°	270°	360°																	
32	204.2	248.0	289.0	331.6	0.236	10	30	15.5	14	10	22	M6	46	G1/8	3	5	30	30	14	50	34.5
40	220.3	267.5	314.5	360.5	0.262	10	35	15.5	16	12	22	M6	54	G1/4	4	5	30	30	14	60	39.5
50	250.6	307.0	362.6	419.2	0.314	10	40	18.5	19	14	27	M8	64.5	G1/4	5	6	32	45	16	65	46.5
63	277.2	340.2	401.4	464.2	0.349	10	45	18.5	24	16	27	M10	75.5	G3/8	5	8	38	52	17	73	47.5
80	350.0	434.0	517.0	603.6	0.471	12	45	21.5	28	25	36	M12	94	G3/8	8	8	48	70	20	100	58.5
100	385.8	487.6	587.2	690.0	0.559	12	55	21.5	38	30	36	M14	111	G1/2	8	10	60	80	25	120	67
125	462.0	594.0	726.0	858.0	0.733	10	60	23	38	30	36	M12	134	G1/2	8	10	70	90	25	150	51

Δ = Linear displacement (mm) for each degree of rotation

Ø	J1	K	M	N	O	P	PL	Q	R	RT	S	TG	TF	TM	V	V1	V2	VA	X	Y	ZM	ZF
32	4.5	17	47	4.5	47	6	10	4	30	M6	9	32.5	6.4	4	68	44.5	19	4	29 - 32.5	20	15	15
40	5	17	52.5	4.5	54.5	6	12	4	35	M6	7	38	7.8	5	74	45	22	4	29 - 32.5	25	17	17
50	7	20	63	5.5	64	6	14	6	40	M8	10	46.5	9.3	6	85	51	25	4	32.5 - 37	25	20	20
63	2.5	20	75	5.5	75	6	16	6	45	M8	11	56.5	10.3	8	95	56	27.5	4	32.5 - 37	30	25	25
80	8.5	29	95	5.5	95	10	18	7	50	M10	12.5	72	15.8	10	125	76	39	4	42 - 50.5	35	35	35
100	7	29	108	5.5	110	10	20	7	60	M10	15	89	18.3	14	150	90.5	45.5	4	42 - 50.5	45	45	45
125	7	32.5	125	7	140	12	25	8	50	M12	15	110	18.3	14	188	118	58	6	45 - 54	45	60	60

N.B.: The product is supplied with negative end-of-stroke piston (in the proximity of head A).
The first cycle involves movement of the piston (towards head B) with consequent anti-clockwise rotation of the pinion.

KEY TO CODES

W165 TYPE		050 BORES	1 VERSION	090 ANGLE OF ROTATION •
W165	Rotary actuator with male pinion	032	1 Senza regolazione dell'angolo di rotazione	090
W166	Rotary actuator with female pinion	040	2 Con regolazione dell'angolo di rotazione	180
		050		270
		063		360
		080		
		100		
		125		

• Expressed in sexagesimal degrees.

ACCESSORIES: MAGNETIC SENSORS

RETRACTABLE SENSOR

SENSOR, SQUARE TYPE
Latest generation, secure fixing

SENSOR, OVAL TYPE
Traditional

For codes and technical data, see **chapter A6**.

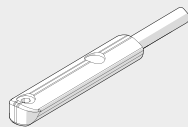
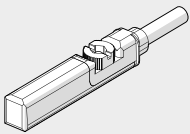

SENSOR SUPPORT BRACKETS FOR SENSORS SQUARE TYPE AND OVAL TYPE

Ø 32 to 40

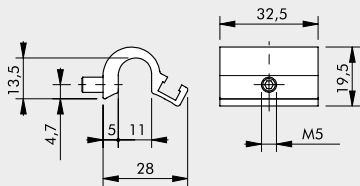

Code W0950001711
Description Bracket D.32-40

Ø 50 to 63

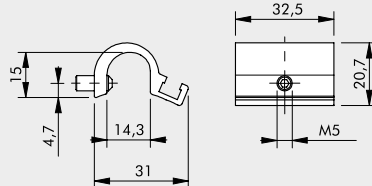

Code W0950001712
Description Bracket D.50-63

Ø 80 to 125

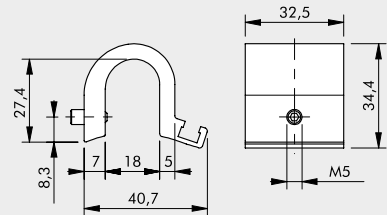

Code W0950001713
Description Bracket D.80-100-125

ADAPTER FOR OVAL TYPE RETRACTABLE SENSORS

ASSEMBLY DIAGRAM

- ① Rotary actuator Serie R1
- ② Sensor bracket mod. DST (Ø 32 to 125)
- ③ Adaptor
- ④ Retractable sensor "oval type"

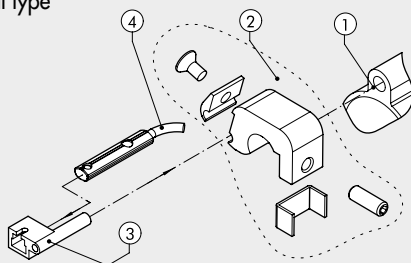

Code W0950001001
Description Adaptor DSS005 for DST/ST brackets

SENSOR SERIES DSM

For codes and technical data, see **chapter A6**.

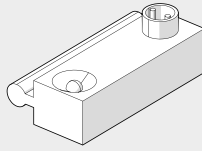

SENSOR SUPPORT BRACKETS FOR SENSORS DSM

Ø 32 to 40

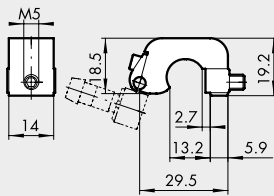

Code	Description
W0950000711	Bracket D.32-40 DST 80

Ø 50 to 63

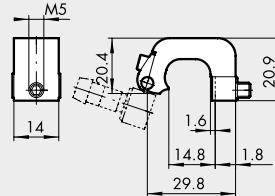

Code	Description
W0950000712	Bracket D.50-63 DST 81

Ø 80 to 125

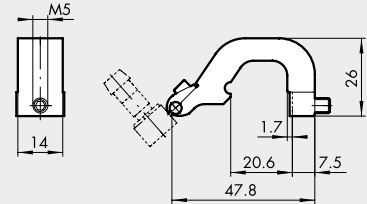

Code	Description
W0950000713	Bracket D.80-100-125 DST 82

NOTES